

TIM-190NH

19 Inch Marine Monitor

GENERAL

This specification defines the descriptions for the TIM-190NH TFT LCD Monitor. TIM series is developed and designed for use in operator display such as Industrial and Marine applications. TIM series are subject to strict quality tests performed both internally and by independent Classification societies in the World such as BV, NK.

KEY FEATURES

- 19.0 inch TFT active-matrix liquid crystal panel
- High Quality TFT with LED Backlight
- 1280 x 1024 resolutions
- Digital DVI-D, Analog RGB Input Signal
- Console Mounting Type
- Power range : 110VAC~230VAC 50/60Hz



GENERAL FEATURE

Section	Specifications
TFT Technology	Active Matrix Liquid Crystal Display Amorphous TFT (Thin Film Transistor) Anti-Glare & Anti-Reflective LED Backlight Technology
Viewable Size	19 inch diagonal
Active Area	376.320mm (H) x 301.060mm (V)
Resolution	1280 x 1024
Pixel Pitch	0.294 (H) x 0.294 (V)
Aspect Ratio	5:4
Response Time	5ms
Brightness	350cd/m ²
Contrast Ratio	1000:1
Viewable Angle	170°RL / 160°UD
Max Colors	16.7Million True Color
Synchronization Range	31~80KHz (Horizontal) 55~76Hz (Vertical)
Optimal Resolution	1280 x 1024 @60Hz
Detectable Resolution	640 x 350, 640 x 480, 720 x 400, 800 x 600, 1024 x 768, 1280 x 1024
Input Signal	1 x VGA (D-SUB 15p female) 1 x DVI-D (DVI 24p female)
Power Specification	110VAC~230VAC 50/60Hz (IEC Standard AC Inlet)
Consumption	40W (MAX)
Product Dimension	483mm (W) x 74.5mm (D) x 400mm (H)
Weight	9.39kg
Operation Conditions	Temperature : 0°C to +50°C Humidity : up to 95%
Storage Conditions	Temperature : -20°C to +60°C Humidity : up to 95%
Options	Dimming : 0~100%
Test Approval	IACS E-10
Certification	BV, NK

MARINE LCD MONITOR

TIM-190NH

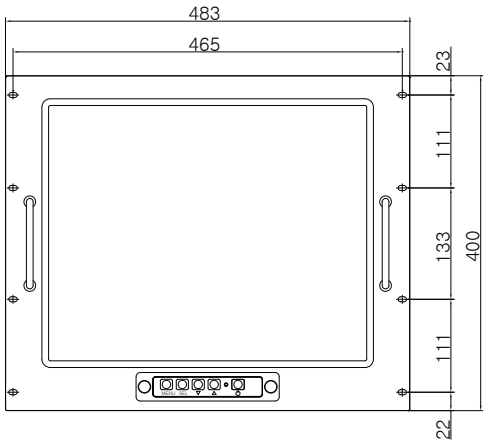

FRONT VIEW

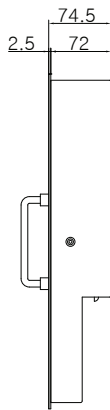

SIDE VIEW

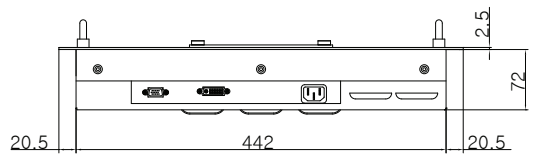

BOTTOM VIEW

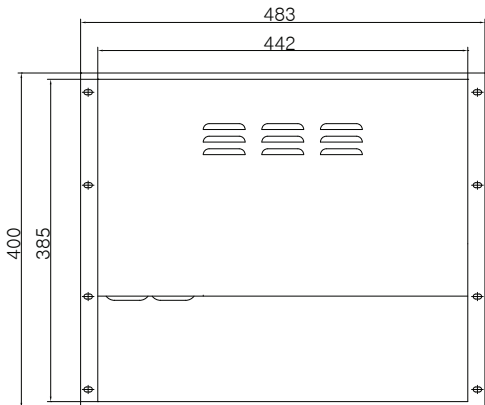

REAR VIEW

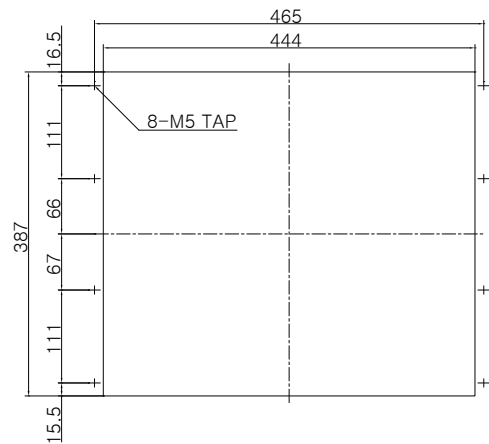

PANEL CUTTING

Tetradyne Co., LTD.

#604/605, E&C VENTURE DREAM TOWER II, 55,
DIGITAL-RO 33-GIL, GURO-GU, SEOUL, 08376, REP KOREA
Tel : +82-2-323-4972
E-mail : sales@tetradyne.co.kr
Web site : www.tetradyne.co.kr

Contact Point

Specifications and features are subject to change without notice.

All products names are trademarks or registered trademarks of Tetradyne.co.,Ltd.